



CE 0123

Ultrasonic Scaler Instruction Manual

(MaxPiezo7, MaxPiezo7+)

Please read this manual before operating

Guilin Refine Medical Instrument Co., LTD.

RF-MP7-M001 Version: 2.0 20241015

Contents















1 Product introduction	1
2 Installation and adjustment	3
3 Function and operation	5
4 Instruction for main components of detachable handpiece (Showned in picture 2)	6
5 Cleaning, disinfecting and sterilizing	7
6 Transportation, storage and maintenance	7
7 Trouble shooting	8
8 Environmental protection	9
9 EMC - Declaration of conformity	9
10 Disposal and Scrapping	13
Attachment 1. Table of operating power of the tips	14
Attachment 2. Reprocessing instructions of cleaning, disinfecting and sterilizing	15

⚠ Safety Precautions

⚠ WARNING: If you neglect these safety precautions, you may cause personal injury such as electric shock, fire or damage to the product.

1. Use a separate, grounded power outlet. Never use wet hands to unplug the power cord.
2. Please put the power plug into the socket easy to pull out, to make sure it can be pulled out in emergency. Please do not use other than the specified voltage.
3. Do not damage, modify, pull, over bend or twist the power cord, do not place heavy objects on the power cord.
4. Do not place the product on unstable workbenches, such as shaky tables, bevels, or vibrations.
5. Keep the scaler clean before and after operation. The scaling tip, wrench and handpiece (detachable) must be sterilized before each treatment.
6. The tip must be tightened to the handpiece with torque wrench. While scaler is working, the heat of scaling tip may become higher if there is no water flowing out, make sure the irrigation is good.
7. Don't twist or rub the tip. Change a new one when the tip is damaged or worn excessively.
8. Don't screw the scaling tip while stepping on the foot switch.
9. Don't use impure water source, and be sure not to use normal brine instead of pure water source.
10. If use the water source without hydraulic pressure, the water surface should be one meter higher than the head of the patient.
11. Don't knock or rub the handpiece. Do not pull the cable while the device is working, to avoid damage to the cable.
12. After operating, turn off electrical source, and then pull out the plug.
13. The screw thread of the scaling tips produced by other manufacturers is maybe coarse, rusty and collapsed, which will damage the screw thread of the handpiece irretrievably. Please use our scaling tip.
14. This equipment is only applicable to the corresponding type of power adapter produced by our company.
15. As a professional manufacturer of medical instruments, we are only responsible for the safety on the following conditions:
 - The maintenance, repair and modification are made by the manufacturer or the authorized dealer.
 - The changed components are original of our company and operated correctly according to instruction manual.
16. This product is intended for use in hospitals and dental clinics only. The user must be professionally trained and qualified dentists.
17. Indicator light: Other colours: Meaning other than red, yellow, or green, indicated the device ready for use.
18. Statement: the third conductor in the POWER SUPPLY CORD is only a functional earth.
19. The device must not be used in MRI environment for the device is easily affected by the electromagnetic emission and would not work or work normally.
20. When you meet circumstances where the main unit expires, the misuses lead to the short circuit of the circuit board or accidentally dropping the device results in the damage of components, the device should no longer be reused.
21. The system (Ultrasonic Scaler and Ultrasonic Scaler Tip) have verified their mutual compatibility in the design stage and performed the final inspection before delivery. They are used in combination to meet the claimed intended use.

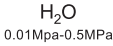
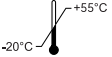
Symbol instruction

Symbol	Instruction	Symbol	Instruction
	Caution		Refer to instruction manual/booklet
	Date of manufacture		Manufacturer
	Class II equipment		Type B applied part
	Foot switch		For indoor use only
	Adjustment for the water flow		Sterilizable in a steam sterilizer (autoclave) at 134°C
24VAC	24VAC power supply socket		Waste electrical and electronic equipment
220VAC	220VAC power supply socket	OPTION	Function selection
	Atmospheric pressure limitation: 70kPa-106kPa		Water entrance pressure:0.01MPa-0.5MPa
	Temperature limit: -20°C- +55°C		Humidity limitation: 10%-93%
IPX1	Protected against dripping water	EC REP	Authorized representative in the European Community
SN	Serial number	UDI	Unique device identifier
MD	Medical device	CE 0123	CE marking with identification number of the Notified Body

1 Product introduction

1.1 Product overview

Guilin Refine Medical Instrument Co.,Ltd. is a professional manufacturer to research, develop, produce and sell ultrasonic scalers. The product is used for teeth cleaning and also an important device for teeth disease prevention and treatment. The Ultrasonic scaler is composed of main unit, handpiece, cable, water pipe, torque wrench, foot switch, and power supply.

The ultrasonic scaler has following features:

1.1.1 Detachable handpiece can be autoclaved under 134°C and 0.22 Mpa.

1.1.2 Automatic frequency tracking ensures that the device always works on the best frequency, stable and efficient performance.

1.2 Intended use

The ultrasonic scaler is intended use in periodontology, for the removal of plaque and calculus, for the cleaning of tooth surfaces and root canals.

1.3 Contraindications:

- 1) The hemophilia patient is forbidden to use this equipment.
- 2) The patients or doctors with heart pacemaker are forbidden to use this equipment.
- 3) The heart disease patient, pregnant woman and children should be cautious to use the equipment.

1.4 Intended patient population

Adults and pediatrics with the periodontal disease treatment or periodontal cleaning regularly.

1.5 Intended user

The Ultrasonic Scaler is intended to be operated by professionally trained and qualified dentist.

1.6 Equipment safety classification

- 1) Operating mode: Continuous operation
- 2) Type of protection against electric shock: Class II
- 3) Degree of protection against electric shock: Type B applied part
- 4) Applied part of the equipment: Tip
- 5) Degree of protection against harmful ingress of water: Ordinary equipment
- 6) Degree of protection against harmful ingress of water: Protection degree against water (used on foot switch): IPX1
- 7) Degree of safety of application in the presence of a flammable anesthetic mixture with air or with oxygen or nitrous oxide: Equipment can not be used in the presence of a flammable anesthetic mixture with air or with oxygen or nitrous oxide

1.7 Model and technical parameters

Parameters	MaxPiezo7	MaxPiezo7+
Tip thread specifications for compatibility	M3*0.5	M3*0.5
Size (mm)	245mm*168mm*150mm	245mm*168mm*150mm
Weight of main unit	1.8kg	1.8kg
Weight of power supply	----	----
Power Supply: External voltage unit	220VAC 50Hz	220VAC 50Hz
Input power	38VA	38VA
Fuse of main unit	T0.5AL 250V	T0.5AL 250V
Fuse of power supply	----	----
Primary tip vibration excursion	1μm-90μm	1μm-90μm
Tip vibration frequency	28kHz±5kHz	28kHz±5kHz
Output power of tip	3W-20W	3W-20W
Half-excursion force	0.1N-2N	0.1N-2N
Water entrance pressure	0.01MPa-0.5MPa	0.01MPa-0.5MPa
Handpiece model	HP-3H (Without LED lamp, Detachable)	HP-5L (With LED lamp, Detachable)
Function setting	G, P, E	G, P, E
Touch control	YES	YES
Water bottle	With	With

Note 1: In addition to the above, the electronic components used to clarify their electrical properties are exactly the same.

Note 2: Function annotation: "G" means "Scaling mode"; "P" means "Periodontal mode"; "E" means "Endodontic mode"

Note 3: Do not replace the fuse of main unit nor the power supply, to avoid safety risks.

1.8 Working condition

- 1) Environment temperature: +5°C-+40°C
- 2) Relative humidity: 30%-75%

- 3) Atmosphere pressure: 70kPa-106kPa
- 4) Temperature of the water at the inlet: not higher than +25°C

2 Installation and adjustment

2.1 Product installation steps

- 2.1.1 Unpack the package, make sure that all the parts and accessories are complete according to the packing list, take the main unit out of the box, and put it on the stable plane facing to the operator.
- 2.1.2 Insert the plug of the foot switch to the socket.
- 2.1.3 Connect the handpiece (detachable) to the cable.
- 2.1.4 Install the tip on the handpiece and turn on the power switch to start operation.

2.2 The function instructions and the connection diagram

- 2.2.1 Power adjustment: The models with potentiometer are adjusted by potentiometer, turn on/off the potentiometer to adjust the power; for the models with touch panel, power can be adjusted by finger touch.
- 2.2.2 Water adjustment: Water is adjusted by touch panel.

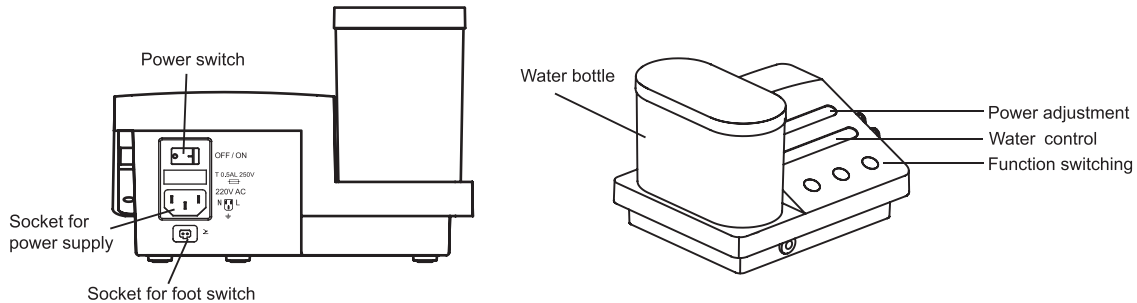

Picture 1 The front view of the main unit (MaxPiezo7, MaxPiezo7+)

2.3 Instruction for main components of handpiece (showed in picture 2).

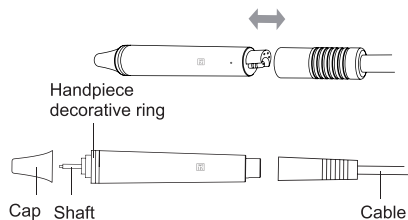

Picture 2-A The handpiece without LED lamp

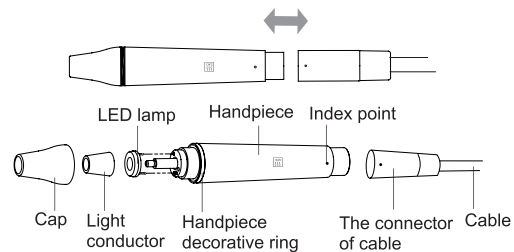

Picture 2-B The handpiece with LED lamp

2.4 Instruction for using the wrench to install tip

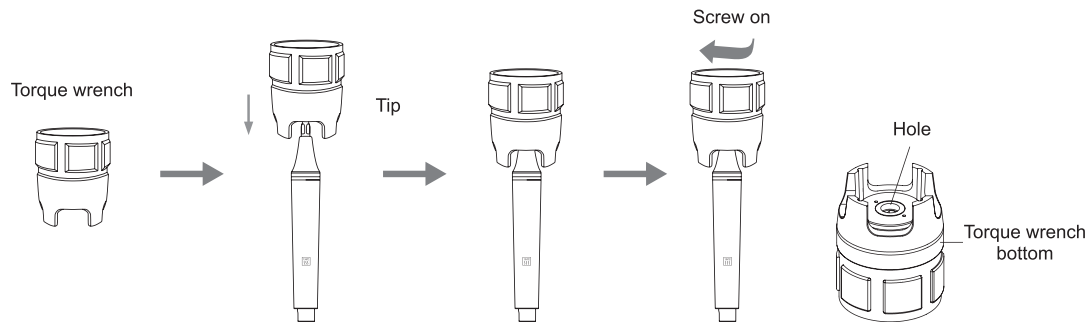

Picture 3

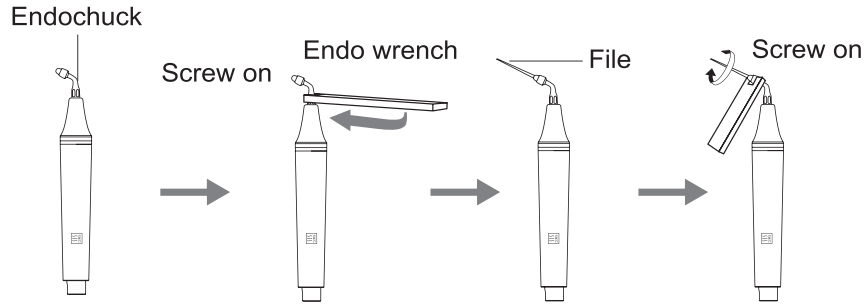

Picture 4

a) The torque wrench's structure is designed in special way which can control the strength of the scaling tip installation properly and correctly. It also can guarantee the operator screw or unscrew the scaling tip effectively and keep their hands away from being scratched.

b) Operation

- Take the tip into the torque wrench then install or uninstall the scaling tip as picture 3 showed.

- Installation: Hold the handpiece and turn the tip toward clockwise direction with the torque wrench. Turn one more circle when the tip stops, then the tip is installed.

- Uninstallation: Hold the handpiece, turn the wrench toward anti-clockwise direction.

⚠️Note: The connection of handpiece (detachable) and the plug must be kept dry.

3 Function and operation

3.1 Scaling & periodontal treatment function

3.1.1 Turn on the power switch, the power indicator lighted and the machine is ready for work.

3.1.2 Choose the scaling tip according to the requirement, and fix the scaling tip with the wrench. (see picture 3) Please select a suitable power when using different type of tips (refer to "TABLE OF OPERATING POWER OF THE TIPS").

3.1.3 The handpiece can be handled in the same gesture as a pen in hand.

3.1.4 Vibrating intensity: Adjust the vibrating intensity according to your need, usually adjust to the middle grade, and adjust the vibrating during the clinical treatment according to the patient's sensitivity and the rigidity of the tartar.

3.1.5 Step on the foot switch, the tip begins to vibrate, and the LED lamp (model with LED) on the top of the handpiece lights up. Release the foot switch, the LED lamp keep shining for 10 seconds.

3.1.6 Under normal working condition, the frequency of the tips is very high, light touch and a certain to-and-fro motion will eliminate the tartar without obvious heating,

overexertion and overstay are forbidden.

3.1.7 Water volume adjustment: Step on the foot switch, and the tip begins to vibrate, then turn the water control switch to fine spray to cool down the handpiece and clean the teeth.

3.1.8 After finishing operation, keep the machine working for 30 seconds with the water supply to clean the handpiece and the tip.

3.1.9 Unscrew the scaling tip and sterilize it.

⚠️Note: Be sure not to make the end of the tip touch the teeth vertically, and not use too much force when the tip touching the surface of the teeth, in case of hurting the teeth and damaging the tip.

⚠️Note: Don't screw the scaling tips when stepping on the foot switch, while the machine is working.

⚠️Note: When the water is lower than water level lower limit, please open the lid, fill the bottle with adequate purified water and cover the lid.

3.2 Endo function (root canal treatment)

3.2.1 Fix endochuck to handpiece by endo wrench (See Picture 4).

3.2.2 Unscrew the screw cap on the endochuck.

3.2.3 Put the ultrasonic file into the hole in the front of endochuck.

3.2.4 Screw the screw cap with endo wrench to tighten up the ultrasonic file.

3.2.5 Press option key, turn to endo function.

3.2.6 When ultrasonic scaler turns into endo function, only the first power indicator is on and the power is at the 1st grade. Put the ultrasonic file into the patient's root canal slowly, step on the foot switch to start endo treatment. During the treatment, turn up the power gradually according to the needs.

⚠️Note:

- a) When fixing endochuck, it must be screwed down.
- b) The screw cap on the endochuck must be screwed down.
- c) Don't press it too much when the ultrasonic file in root canal.
- d) Don't step on the foot switch until the ultrasonic file is in root canal.
- e) The power range of endo treatment is advised from the 1st to the 5th grade.

4 Instruction for main components of detachable handpiece (Showed in picture 2)

a) Cap: The cap can be removed. You can screw out the cap and clean the pole with alcohol termly.

b) Decorative ring: can be disassembled and cleaned with alcohol regularly, can be autoclaved under the high temperature and pressure.

c) Handpiece: The main part of the whole handpiece, can be autoclaved under the high temperature and pressure.

d) Symbol: Autoclaved (134°C, 0.22MPa)

e) The connector of the cable: Connect the handpiece with the water source and power supply of the main unit.

f) LED lamp, Light conductor (The models that the handpiece with LED lamp): Clean them with purified water and sterilize them under the high temperature of 134°C and high pressure of 0.22Mpa.

⚠️Note: The connection of handpiece and the plug must be kept dry.

5 Cleaning, disinfecting and sterilizing

5.1 Please conform to the recommendations of the manual "Reprocessing Instructions of Cleaning, Disinfecting and Sterilizing" delivered with your product regarding the procedure of cleaning, disinfecting, sterilizing and packing of the components.

5.2 The handpiece (detachable), endochuck, torque wrench, endo wrench, LED lamp and Light conductor (the handpiece with LED lamp) can be sterilized.

•Recommended reprocessing cycles of handpiece, endochuck, torque wrench and endo wrench: 300 cycles

⚠ Notice:

- a) Clean the handpiece (detachable) with compressed air before sterilization.
- b) Be sure that the scaling tip has been unscrewed from the handpiece and it cannot be sterilized with others.
- c) Please notice whether the outer of the handpiece is damaged during the treatment and sterilization. Don't smear any protective oil on the surface of handpiece.
- d) There are two waterproof "O" rings at the end of the handpiece. Please lubricate them with dental lube frequently, as sterilization and repeated pulling and inserting will reduce their using life. Change a new one once it is damaged or worn excessively.
- e) The following sterilizing methods are forbidden:
 - Boil in water.
 - Dip in iodine, alcohol and glutaraldehyde.
 - Bake in oven or microwave oven.

⚠ Notice: We are not responsible for any damage caused in the above items.

⚠ Notice: For cleaning and disinfection, use disinfectant ethanol or disinfectant isopropanol that does not contain any additives (any quaternary ammonium salts). Use of other disinfectants may cause discoloration or cracking.

* For details, contact the manufacturer of the disinfectant.

* In this operation manual, disinfectant ethanol or disinfectant isopropanol that does not contain any additives (any quaternary ammonium salts) is called by "disinfectant alcohol".

6 Transportation, storage and maintenance

6.1 Transportation

6.1.1 Excessive impact and shake should be prevented in the transportation. Lay it carefully and lightly and don't invert it.

6.1.2 Don't put it together with dangerous goods during transportation.

6.1.3 Avoid solarization and getting wet in rain or snow during transportation.

6.2 Storage

6.2.1 Don't store the machine together with the articles that are combustible, poisonous, caustic or explosive.

6.2.2 This equipment should be stored in a room where the relative humidity is 10%-93%, atmospheric pressure is 70kPa-106kPa, and the temperature is -20°C - +55°C.

6.3 Maintenance

6.3.1 The equipment should be handled carefully and lightly. Be sure that it is far from the vibration, and installed or kept in a cool, dry and ventilated place.

6.3.2 Please turn off the electrical source if not use it, if not use for a long time, please make the machine get through to the power and water once 3 months for five minutes.

7 Trouble shooting

Fault	Possible cause	Solutions
The scaling tip doesn't vibrate and there is no water flowing out when stepping on the foot switch.	The power plug is in loose contact.	Make the plug insert to the socket well.
	The foot switch is in loose contact.	Insert the foot switch to its socket tightly.
	The fuse in the main unit is broken.	Contact our dealers or us.
The scaling tip doesn't vibrate but there is water flowing out when stepping on the switch.	The tip is in loose contact.	Screw the tip on the handpiece tightly (See Picture 3).
	The connect plug between the handpiece and the circuit board is in loose contact.	Contact our dealers or us.
	Something wrong with the handpiece.	Send the handpiece to our company to repair.
	Something wrong with the cable.	Contact our dealers or us.
The scaling tip vibrates but there is no spray when stepping on the foot switch.	The water control knob is not on.	Turn on the water control knob [note 1].
The vibration of the tip becomes weak.	The tip hasn't been screwed on to the handpiece tightly.	Screw the tip on the handpiece tightly (See Picture 4).
	The tip is loose because of vibration.	Screw on the tip tightly (See Picture 4).
	The coupling between the handpiece and the cable isn't dry.	Dry it by the hot air.
	The tip is damaged [note 2].	Change a new one.
There is water seeping from the coupling between the handpiece and cable.	The waterproof "O"ring is damaged.	Change a new waterproof "O"ring.
There is water flowing out when turn off the power.	There is impurity in the solenoid valve.	Contact with the local distributor or manufacturer.
The handpiece generates heat.	The amount of spouting water is too little.	Turn the water control switch to a higher grade [note 1].
	The potentiometer is broken.	Change a new one.
The amount of spouting water is too little.	The water control knob is a low grade.	Turn the knob to a high grade [note 1].
	The water pressure is not enough.	Enhance the water pressure.
	The water pipe is jammed.	Clean water pipe with multi-function syringe [note2].

Fault	Possible cause	Solutions
The vibrating intensity control knob seizes up.	The potentiometer is damaged.	Contact with the local distributor or our company.
The u-file doesn't vibrate.	The screw is loose.	Tighten it.
	Endochuck is damaged.	Change a new one.
There is noise coming from the endochuck.	The screw is loose.	Tighten it.
LED light don't work (Handpiece with LED lamp)	Poor contact	Contact tightly
	Something wrong with LED light	Change a new one
There is no water coming out from the handpiece (automatic water supply mode).	There is air in the water pipe.	Turn the water control to the Max, reinsert the bottle.

If the problem still can't be solved, please contact with local dealer or manufacturer.

8 Environmental protection

Please dispose according to the local laws.

9 EMC - declaration of conformity

9.1 Instructions for use

The ME EQUIPMENT or ME SYSTEM use in hospitals or dental clinics.

Warning: Don't near active HF surgical equipment and the RF shielded room of an ME system for magnetic resonance imaging, where the intensity of EM disturbances is high.

Warning: Use of this equipment adjacent to or stacked with other equipment should be avoided because it could result in improper operation. If such use is necessary, this equipment and the other equipment should be observed to verify that they are operating normally.

Warning: Use of accessories, transducers and cables other than those specified or provided by the manufacturer of this equipment could result in increased electromagnetic emissions or decreased electromagnetic immunity of this equipment and result in improper operation.

Warning: Portable RF communications equipment (including peripherals such as antenna cables and external antennas) should be used no closer than 30 cm (12 inches) to any part of the equipment, including cables specified by the manufacturer. Otherwise, degradation of the performance of this equipment could result.

Note: The emissions characteristics of this equipment make it suitable for use in industrial areas and hospitals (CISPR 11 class A). If it is used in a residential environment (for which CISPR 11 class B is normally required) this equipment might not offer adequate protection to radio-frequency communication services. The user might need to take mitigation measures, such as relocating or re-orienting the equipment.

List of all cables

No	Name	Length	Shielded or not
1	Power cord	2.0 m	No
2	Foot Switch cord	2.5 m	No
3	Ultrasonic Scaler Handpiece Cord	2.0 m	No

Replaceable accessories

No	Name	Model	Connection method	Note
1	Ultrasonic Scaler Handpiece	Refer to packing list	plug	/
2	Power cord	/	plug	/
3	Foot Switch	RFS02	plug	/

Performance of the me equipment

Ultrasonic Scaler is used for cleaning and shaping the surface and root area on the teeth. If the measured field strength to which the ultrasonic scaler is located is above the applicable RF compliance level, the ultrasonic scaler should be observed to verify if the performance is in proper operation. If abnormal performance is observed, additional measures may be necessary, such as reorienting or repositioning the ultrasonic scaler.

When the me equipment essential performance is ineffective or degraded due to em disturbances, the doctor should immediately stop using it to ensure that there is no treatment error. And then remove the source of disturbances or adjust the direction or position of me equipment to ensure me equipment can be used in normal performance condition.

9.2 Technical description

9.2.1 Portable and mobile RF communications equipment may affect the performance of equipment , use of equipment should be avoided strong electromagnetic interference, and do not closer to mobile phone, microwave oven, etc.

9.2.2 Use of equipment adjacent to or stacked with other equipment should be avoided because it could result in improper operation. If such use is necessary, this equipment and the other equipment should be observed to verify that they are operating normally.

9.2.3 Except for the cables sold by manufacturers of as spare parts of internal components, the use of accessories and cables other than those specified or provided by the manufacturer may result in increased electromagnetic emissions or decreased electromagnetic immunity of this equipment and result in improper operation.

9.2.4 Use of accessories, transducers and cables other than those specified or provided by the manufacturer together with equipment could result in increased electromagnetic emissions or decreased electromagnetic immunity of this equipment and result in improper operation.

Guidance and manufacturer's declaration -electromagnetic emissions and Immunity

Table 1

Guidance and manufacturer's declaration - electromagnetic emissions	
Emissions test	Compliance
RF emissions CISPR 11	Group 1
RF emissions CISPR11	Class B
Harmonic emissions IEC 61000-3-2	Not Applicable
Voltage fluctuations / flicker emissions IEC 61000-3-3	Not Applicable

Table 2

Guidance & declaration — electromagnetic immunity		
Immunity test	IEC 60601-1-2 test level	Compliance level
Electrostatic discharge (ESD) IEC 61000-4-2	±8 kV contact ±2 kV, ±4 kV, ±8 kV, ±15 kV air	±8 kV contact ±2 kV, ±4 kV, ±8 kV, ±15 kV air
Electrical fast transient/burst IEC 61000-4-4	±2 kV power supply lines ±1 kV signal input/output 100 kHz repetition frequency	±2 kV power supply lines Not applicable 100 kHz repetition frequency
Surge IEC 61000-4-5	±0.5 kV, ±1 kV differential mode ±0.5 kV, ±1 kV, ±2 kV common mode	±0.5 kV, ±1 kV differential mode Not applicable
Voltage dips, short interruptions and voltage variations on power supply input lines IEC 61000-4-11.	0 % UT; 0,5 cycle. At 0°, 45°, 90°, 135°, 180°, 225°, 270° and 315°. 0 % UT; 1 cycle and 70 % UT; 25/30 cycles; Single phase: at 0°. 0 % UT; 250/300 cycle	0 % UT; 0,5 cycle. At 0°, 45°, 90°, 135°, 180°, 225°, 270° and 315°. 0 % UT; 1 cycle and 70 % UT; 25/30 cycles; Single phase: at 0°. 0 % UT; 250/300 cycle
Power frequency (50/60 Hz) magnetic field IEC 61000-4-8	30 A/m 50Hz/60Hz	30 A/m 50Hz/60Hz

Conducted RF IEC61000-4-6	3 V 0,15 MHz – 80 MHz 6 V in ISM bands between 0,15 MHz and 80 MHz 80 % AM at 1 kHz	3 V 0,15 MHz – 80 MHz 6 V in ISM bands between 0,15 MHz and 80 MHz 80 % AM at 1 kHz
Radiated RF IEC61000-4-3	3 V/m 80 MHz – 2,7 GHz 80 % AM at 1 kHz	3 V/m 80 MHz – 2,7 GHz 80 % AM at 1 kHz
NOTE U _r is the a.c. mains voltage prior to application of the test level.		

Table 3

Guidance & Declaration - Electromagnetic immunity						
	Test Frequency (MHz)	Band (MHz)	Service	Modulation	IEC 60601-1-2 Test Level (V/m)	Compliance level (V/m)
Radiated RF IEC61000-4-3 (Test specifications for ENCLOSURE PORT IMMUNITY to RF wireless communications equipment)	385	380 – 390	TETRA 400	Pulse modulation 18 Hz	27	27
	450	430 – 470	GMRS 460, FRS 460	FM ± 5 kHz deviation 1 kHz sine	28	28
	710	704 – 787	LTE Band 13, 17	Pulse modulation 217 Hz	9	9
	745					
	780					
	810					
	870	800 – 960	GSM 800/900, TETRA 800, iDEN 820, CDMA 850, LTE Band 5	Pulse modulation 18 Hz	28	28
	930					
	1720	1700 – 1990	GSM 1800; CDMA 1900; GSM 1900; DECT; LTE Band 1, 3, 4, 25; UMTS	Pulse modulation 217 Hz	28	28
	1845					
	1970					
	2450	2400 – 2570	Bluetooth, WLAN, 802.11 b/g/n, RFID 2450, LTE Band 7	Pulse modulation 217 Hz	28	28
	5240	5100 – 5800	WLAN 802.11 a/n	Pulse modulation 217 Hz	9	9
	5500					
5785						

Table 4

Guidance and manufacturer's declaration - electromagnetic Immunity				
Radiated RF IEC61000-4-39 (Test specifications for ENCLOSURE PORT IMMUNITY to proximity magnetic fields)	Test Frequency	Modulation	IEC 60601-1-2 Test Level (A/m)	Compliance level (A/m)
	30 kHz	CW	8	8
	134,2 kHz	Pulse modulation 2.1 kHz	65	65
	13,56 kHz	Pulse modulation 50 kHz	7,5	7,5

10 Disposal and Scrapping

The product doesn't contain battery or toxic substances. And there are no components which should be removed specially from the main unit for disposal and scrapping.

After the device is out of its service life, you must not discard it in domestic household waste. Please comply with the Waste Electrical and Electronic Equipment (WEEE) directives and the medical waste disposal regulations of your country.

Torque wrench, endo wrench and handpiece, those which could easily contact to the biological sources and cause biological hazards, shall be detached from the main unit and reprocessed according to the reprocessing treatment in Attachment 2 before the disposal and scrapping.

Attachment 1. Table of operating power of the tips

Scaling	
Tip Model	Power
G1	1-10(G)
G2	1-10(G)
G3	1-10(G)
G4	1-10(G)
G5	1-10(G)
G6	1-10(G)
G7	1-10(G)
G8	1-10(G)
G9	1-10(G)
G10	1-10(G)
G11	1-10(G)

Cavity Preparation	
Tip Model	Power
SB1	1-10(P)
SB2	1-10(P)
SB3	1-10(P)
SBL	1-10(P)
SBR	1-10(P)

Periodontics	
Tip Model	Power
P1	1-10(P)
P2L	1-3(P)
P2LD	1-2(P)
P2R	1-3(P)
P2RD	1-2(P)
P3	1-6(P)
P3D	1-6(P)
P4	1-6(P)
P4D	1-6(P)

Endodontics	
Tip Model	Power
E1	1-5(E)
E2	1-5(E)
E3	1-6(E)
E3D	1-3(E)
E4	1-6(E)
E4D	1-3(E)
E5	1-6(E)
E5D	1-3(E)
E6	1-6(E)
E7	1-6(E)
E8	1-10(E)
E9	1-10(E)
E10	1-6(E)
E10D	1-6(E)
E11	1-6(E)
E11D	1-6(E)
E14	1-3(E)
E15	1-3(E)

Attachment 2. Reprocessing instructions of cleaning, disinfecting and sterilizing

1. Beginning work

1.1 Please read these operating instructions carefully as they explain all the most important details and procedures. Please pay special attention to the safety precautions. Always keep this instruction close at hand.

1.2 To prevent injury to people and damage to property, please heed the corresponding directives.

1.3 The instructions in this manual are only applicable to the product which it was delivered with.

2. Introduction

2.1 These reprocessing instructions provide instructions for cleaning, disinfection, sterilization and packaging of manufacturer reusable products intended to be reprocessed in medical facilities.

2.2 The goal of reprocessing reusable products is to reduce bioburden and to achieve sterility of those products in order to eliminate the risk of product reuse related infection. Decisions regarding cleaning, disinfecting or sterilizing manufacturer's medical and dental instruments are based on the potential risk of infection associated with their use.

2.3 It is recommended to use steam sterilization.

2.4 Remember that sterilization or high-level disinfection cannot be achieved unless the elements of the assembly are cleaned first.

2.5 If you find that the reprocessing instructions from the manufacturer seem to be inadequate, please inform manufacturer about those inadequacies.

2.6 We encourage you to report adverse events related to device reprocessing. Report such events directly to manufacturer.

3. Reprocessing - instructions for reusable products

3.1 The instructions are binding for the reprocessing of all reusable products (Here after called "products") of manufacturer. When necessary, additional product-specific instructions are included with the product to provide additional information.

⚠ Important: Before use, carefully read the operating instructions of the manufacturer instrument and devices with which the product will be used.

3.2 Reusable products must be cleaned, disinfected and sterilized prior to first use. Reprocessing procedures have only limited implications to this device. The limitation of the numbers of reprocessing procedures is therefore determined by the function / wear of the device. From the processing side there is no maximum number of allowable reprocessing. The device should no longer be reused in case of signs of material degradation.

⚠ In case of damage the product should be reprocessed before sending back to the manufacturer for repair.

4. Preparation - basic principles

4.1 It is only possible to carry out effective sterilization after the completion of effective cleaning and disinfection. Please ensure that, as part of your responsibility for the sterility of products during use, only sufficiently validated equipment and product-specific procedures are used for cleaning/disinfection and sterilization, and that the validated parameters are adhered to during every cycle.

4.2 Please also observe the applicable legal requirements in your country as well as the hygiene regulations of the hospital or clinic. This applies especially with regard to the additional requirements for the

inactivation of prions.

5. Preparation at the point of use

Disconnect product. Remove gross soiling of the products with cold water (<40°C) immediately after use. Don't use a fixating detergent or hot water (>40°C) as this can cause the fixation of residuals which may influence the result of the reprocessing process.

Store the products in a humid surrounding.

6. Transportation

Safe storage and transportation to the reprocessing area to avoid any damage and contamination to the environment.

7. Preparation for decontamination

The products must be reprocessed in a disassembled state, as far as possible.

8. Pre-cleaning

Do a manual pre-cleaning, until the products are visually clean. Submerge the products in a cleaning solution and flush the lumens with a water jet pistol with cold tap water for at least 10 seconds. Clean the surfaces with a soft bristle brush.

9. Cleaning

Regarding cleaning/disinfection, rinsing and drying, it is to distinguish between manual and automated reprocessing methods. Preference is to be given to automated reprocessing methods, especially due to the better standardizing potential and industrial safety.

Automated Cleaning:

Use a washer-disinfector (WD) meeting the requirements of the ISO 15883 series.

Put the products into the machine on a tray. Connect the products with

the WD by using suitable adapter and start the program:

4 min pre-washing with cold water (<40°C)

Emptying

5 min washing with a mild alkaline cleaner at 55°C

Emptying

3 min neutralising with warm water (>40°C);

Emptying

5 min intermediate rinsing with warm water (>40°C)

Emptying

The automated cleaning processes have been validated by using 0.5% neodisher MediClean forte (Dr. Weigert).

⚠️ Acc. to EN ISO 17664 no manual reprocessing methods are required for these devices. If a manual reprocessing method has to be used, please validate it prior to use.

10. Disinfection

Automated Thermal Disinfection in washer/disinfector under consideration of national requirements in regards to A0 value (see EN 15883).

A disinfection cycle of 5 min disinfection at 93°C has been validated for the product to achieve an A0 value of 3000.

11. Drying

Automated Drying:

Drying of outside of products at 40°C, 5 min through drying cycle of washer/disinfector. If needed, additional manual drying can be performed through lint free towel. Insufflate cavities of products by using sterile compressed air.

12. Functional testing, maintenance

Visual inspection for cleanliness of the products and reassembling if required. Functional testing according to instructions of use. If

necessary, perform reprocessing process again until products is visibly clean.

Before packaging and autoclaving, make sure that the products have been maintained acc. to manufacturer's instruction.

13. Packaging

Pack the products in an appropriate packaging material for sterilization. The packaging material and system refer to EN ISO 11607.

14. Sterilization

Sterilization of products by applying a fractionated pre-vacuum steam sterilization process (according to EN 285/EN 13060/EN ISO 17665) under consideration of the respective country requirements.

Minimum requirements: 3 min at 134 °C (in EU: 5 min at 134 °C)

Maximum sterilization temperature: 138°C

Drying time:

For steam sterilization, we recommend a drying time of 15 to 40 minutes. Choose a suitable drying time, depending on the autoclave and load. Refer to the autoclave's instructions for use.

After sterilization:

a. Remove the product from the autoclave.

b. Let the product cool down at room temperature for at least 30 minutes. Do not use additional cooling.

Check that the sterilization wraps or pouches are not damaged.

⚠ Flash sterilization is not allowed on lumen products.

⚠ The manufacturer assumes no responsibility for the use of other sterilization procedures (e.g. ethylene oxide, formaldehyde and low temperature plasma sterilization). In such cases, please observe the respective valid standards (EN ISO 14937/ANSI AAMI ISO 14937 or the procedure-specific standard) and verify the suitability and effectiveness in principle of the procedure (if necessary, including

investigations on sterilizing agent residue), taking into account the specific product geometry as part of the validation.

•Maximum sterilization temperature 138°C

15. Storage

Storage of sterilized products in a dry, clean and dust free environment with a relative humidity of 10% to 93%, an atmospheric pressure of 70KPa to 106KPa, and a temperature of -20 °C to +55 °C; refer to label and instructions for use.

After sterilization, the product should be packaged in a medical sterilization bag or a clean sealing container, and stored in a special storage cabinet. The storage time should not exceed 7 days. If it is exceeded, it should be reprocessed before use.

16. Service life

The products have been designed for a large number of sterilization cycles. The materials used in their manufacture were selected accordingly. However with every renewed preparation for use, thermal and chemical stresses will result in aging of the devices. If the number of permissible re-sterilization cycles is restricted, this will be pointed out in the product specific instructions.

⚠ The use of ultrasound baths and strong cleaning and disinfection fluids (alkalizing pH>9 or acid pH<5) can reduce the life span of devices. The manufacturer accepts no liability in such cases.

⚠ The devices may not be exposed to temperatures above 138 °C. It is the duty of the user to ensure that the reprocessing processes including resources, materials and personnel are capable to reach the required results. State of the art and often national law requiring these processes and included resources to be validated and maintained properly.

Note: We reserve the rights to change the design of the equipment, the technique, fittings, the instruction manual and the content of the original packing list at any time without notice. If there are some differences between blueprint and real equipment, take the real equipment as the norm.

Shelf life: 10 years, the date of manufacture see product label.



Guilin Refine Medical Instrument Co., Ltd.

No.8-3, Information Industrial Park, High-Tech Zone, Qixing District,
541004 Guilin, Guangxi, PEOPLE'S REPUBLIC OF CHINA
Tel: +86-773-7796686 Email: refine@refine-med.com
Website: <http://www.refine-med.com>



MedNet EC-REP C 1lb GmbH
Borkstrasse 10, 48163 Münster, Germany

Scan and Login website for
more information



